

Rotary knob switches

Serie 417

Type 417

Basic design: width 19.4 mm, operation by screwdriver

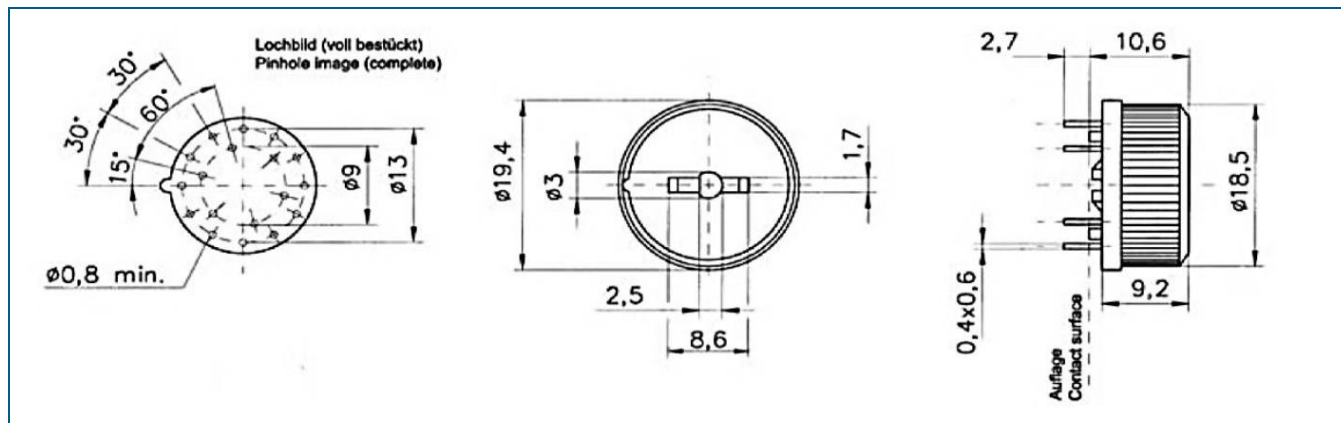
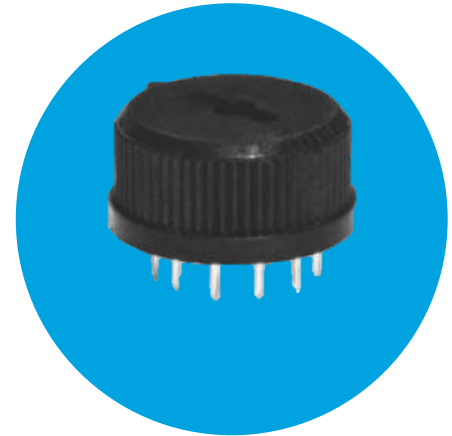

Technical data

Switch resistance initial value	≤ 25 mΩ	Capacity between two contacts	≤ 3 p F
Switch resistance after 15 000 cycles	≤ 50 mΩ	Switching mode	Non shorting (white bottom plate), shorting (black bottom plate)
Insulation resistance	1 x 10 ⁹ Ω	Number of wafers	1 / single wafer
Test voltage	1 kV- / 1 kV DC	Indexing angle	30°
Switching voltage	Max. 150 V DC / AC	Stops	Fixed or without stop
Switching current	Max. 130 mA, Ag plated	Operating torque	2 - 4.5 Ncm
Switching power	Max. 5 VA, Ag plated	Solder terminals	For printed circuit
Steady current at 20 °C ambient temperature	3 A	Contact material	Silver plated copper alloy
Operating life at maximum power	≥ 15 000 cycles	Insulation material	Plastic
Operating life no load	≥ 20 000 cycles	Switching combinations (see page 2)	1 x 2 to 1 x 12; 2 x 2 to 2 x 6; 3 x 2 to 3 x 4; 4 x 2 to 4 x 3; 6 x 2

Rotary knob switches

Serie 417

Type 417

Basic design: width 19.4 mm, operation by screwdriver

Switching Combinations

1-polig
1 Pole

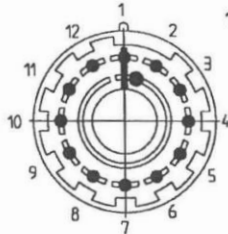

1 x 2 - 1 x 12

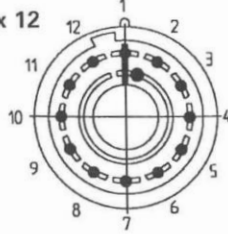

1-polig
durchdrehbar
1 Pole
without stop

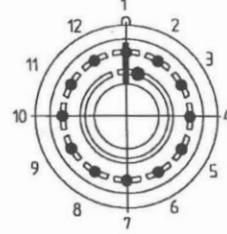

2-polig
2 Pole

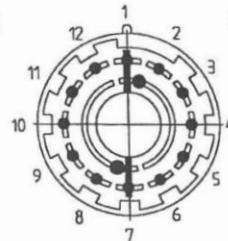

2 x 2 - 2 x 6

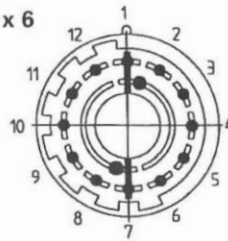

2-polig
durchdrehbar
2 Pole
without stop

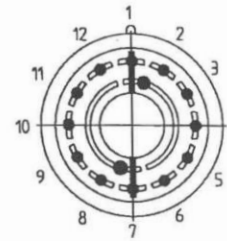

3-polig
3 Pole

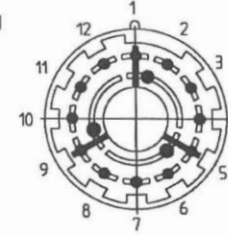

3 x 2 - 3 x 4

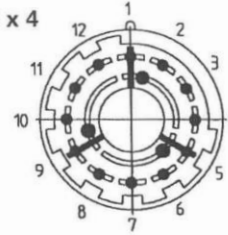

3-polig
durchdrehbar
3 Pole
without stop

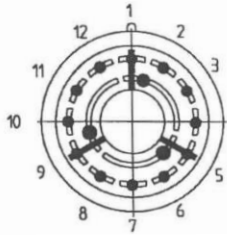

4-polig
4 Pole

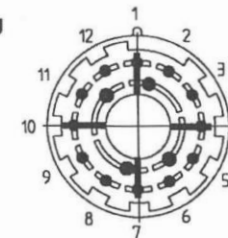

4 x 2 - 4 x 3

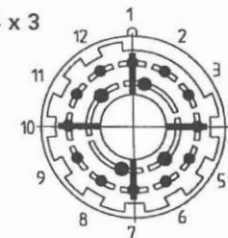

4-polig
durchdrehbar
4 Pole
without stop

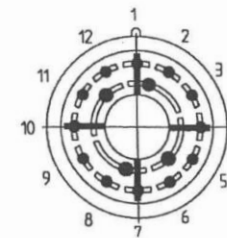

6-polig
6 Pole

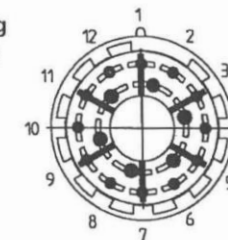

6 x 2



6-polig
durchdrehbar
6 Pole
without stop

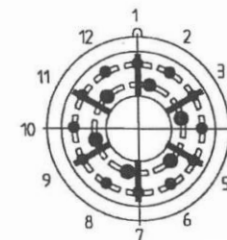

Erläuterung: 2 x 3 ≙ 2-polig, 3 Schaltstellungen

Explanation: 2 x 3 ≙ 2 Pole, 3 Ways